

Wippschalter IP65 Serie B4MASK

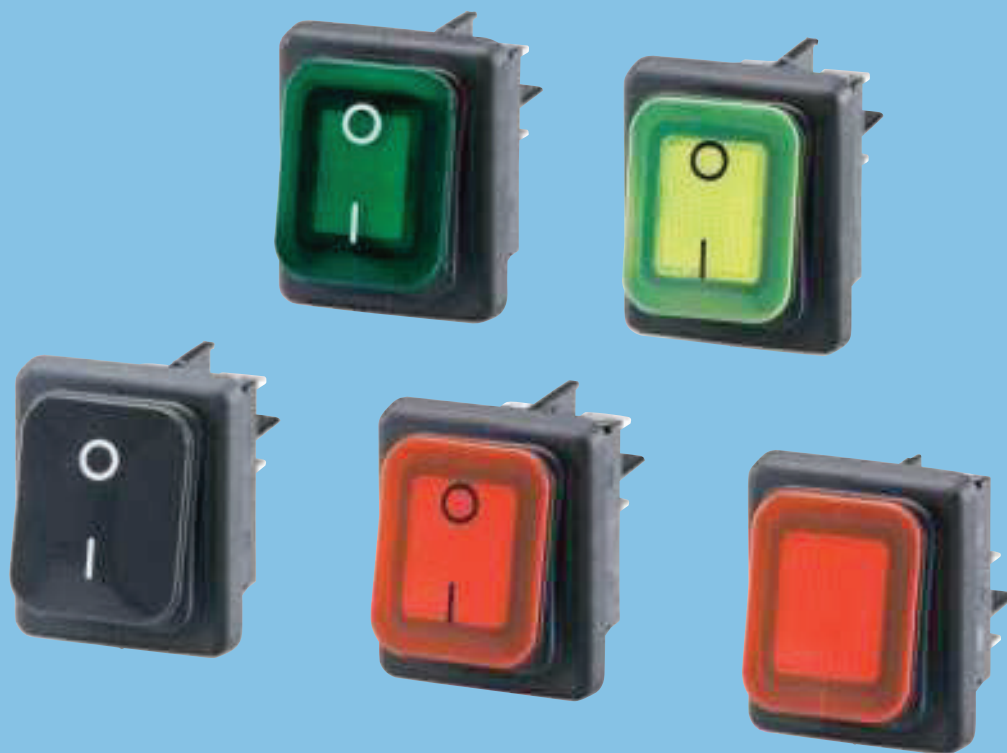

Schemi elettrici disponibili - *Wiring diagrams available*

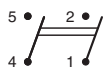

Interruttore bipolare
Double-pole switch

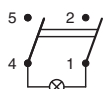

Interruttore bipolare luminoso
Illuminated double-pole switch

Accessori: connettore per cablaggio
Accessories: wiring connector

Wippschalter IP65 Serie B4MASK

Caratteristiche elettriche - Electrical features

Portata	Fino a 16 (8) A
<i>Electrical rating</i>	<i>Up to 16(8) A</i>
Numero cicli elettromeccanici	Fino a 50.000
<i>Electro-mechanical cycles number</i>	<i>Up to 50.000</i>
Temperatura ambiente	Fino a 120°C
<i>Room temperature</i>	<i>Up to 120°C</i>
Infiammabilità	UL 94 V-2
<i>Flammability</i>	
Resistenza al calore e al fuoco	GWFI 850 °C
<i>Heat and fire resistance</i>	<i>GWIT 775°C (category D)</i>
Distanza tra i contatti	≥ 3mm
<i>Contact gap</i>	
Marchi di approvazione	
<i>Approval Marks</i>	
Normative di riferimento	EN61058-1
<i>Reference Standards</i>	<i>UL1054</i>
Grado IP	IP65
<i>IP degree</i>	

Dima - Cut out

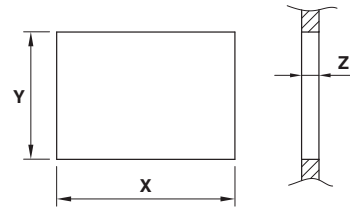







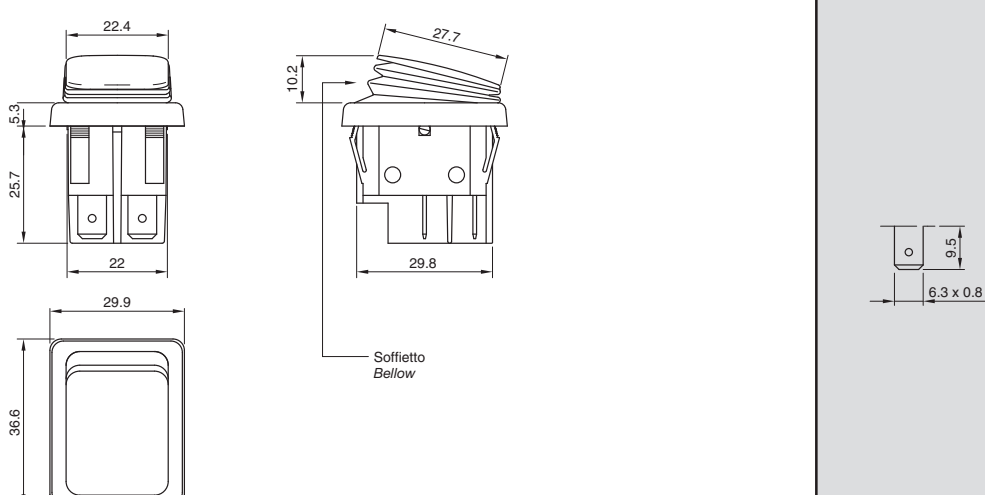



Z	Y	X
0.7 ... 1.25	22.0 ^{+0.2} ₀	30.2 ± 0.1
1.25 ... 2.0	22.0 ^{+0.2} ₀	30.6 ± 0.1
2.0 ... 3.0	22.0 ^{+0.2} ₀	30.8 ± 0.1











Su richiesta disponibile con portata:
On demand, the following rating is available:
 20 (10) A / 250VAC - 14 (14) A / 250VAC - 5E4

Dimensioni e tipologie di terminale - Dimensions and terminal types

Dimensioni <i>Dimensions</i>	Tipo terminale <i>Terminal type</i>
	
<p>Nota. Per il tasto esistono due versioni: lucido e satinato <i>Note. Two rockers models available: gloss- and mat-finished</i></p>	

Wippschalter IP65 Serie B4MASK

 Interruttore bipolare - Double-pole switch					
Portata Rating	Terminale Terminal	Soffietto Bellow	Tasto Rocker	Codice P/N Code	
16 (8) A / 250VAC 12 (10) A / 250VAC 5E4 T120/55 °C 20A – 125 VAC 16A – 250 VAC 3/4 HP – 125 VAC 3/4 HP – 250 VAC T 105°C				B4MASK42N1100000	Tasto lucido Gloss-finished rocker
				B4MASK42N1121000	
				B4MASK42N7721000	
				B4MASK52N1121000	Tasto satinato Mat-finished rocker

 Interruttore bipolare luminoso - Illuminated double-pole switch					
Portata Rating	Terminale Terminal	Soffietto Bellow	Tasto Rocker	Codice P/N Code	
16 (8) A / 250VAC 12 (10) A / 250VAC E4 T120/55 °C 20A – 125 VAC 16A – 250 VAC 3/4 HP – 125 VAC 3/4 HP – 250 VAC T 105°C			 *	B4MASK48N1A11000	Tasto lucido Gloss-finished rocker
				B4MASK48N1E21000	
				B4MASK48N1G21000	
			 *	B4MASK48N1R00000	
			 *	B4MASK48N1R11000	
			 *	B4MASK48N1V11000	
			 *	B4MASK48N1A00000	
				B4MASK48N1G00000	

(*) Colore brillante / Bright colour

Wippschalter IP65 Serie B4MASK

Accessorio: connettore per cablaggio - Accessories: wiring connector

B4CNT

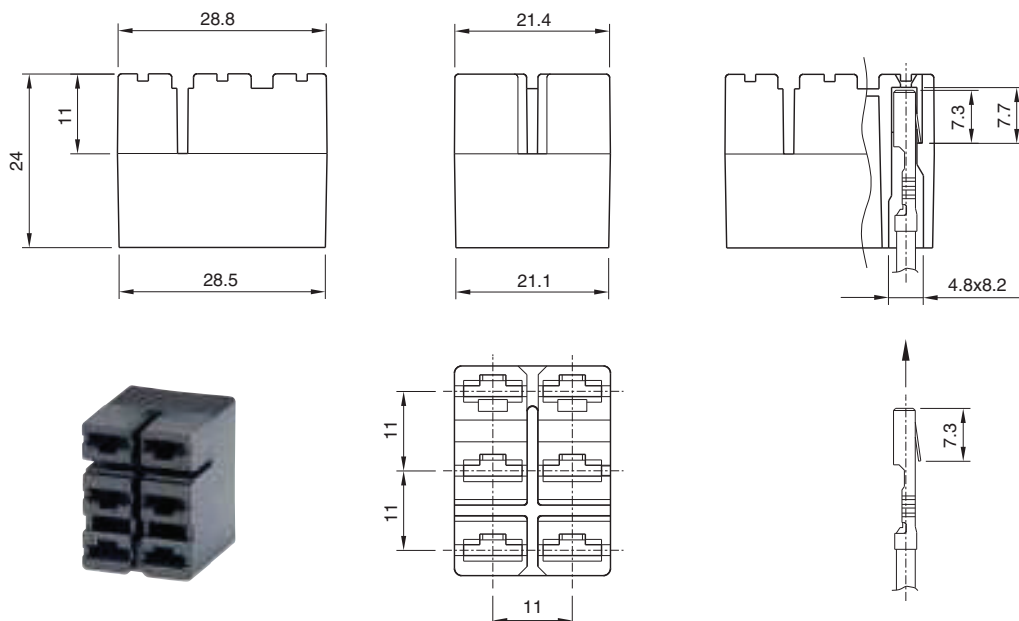

MERSCHJOHANN

James-Watt-Straße 8 • 33334 Gütersloh • Tel (0 5241) 90 46 20 • Fax (0 5241) 90 46 22
E-Mail: sales@merschjohann.com • www.merschjohann.com